

FAC-Series 905 nm High Power Pulsed Laser Diodes with Fast Axis Collimators

Features

- Fast axis collimation
- Hermetic package
- Extremely robust
- High reliability

Applications

- Laser range finding
- Surveying equipment
- Laser radar
- Security barrier

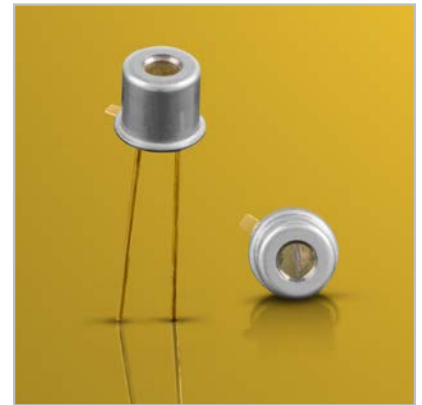

Optical Characteristics at $t_{RT} = 21^{\circ}\text{C}$, I_{FM}

	Min	Typ	Max	Units
Wavelength of peak radiant intensity λ	895	905	915	nm
Spectral width $\Delta\lambda$ at 50% intensity points at I_{FM}		8		nm
Wavelength temperature coefficient		0.27		nm/ $^{\circ}\text{C}$
Divergence, w.r.t. junction plane Parallel, \parallel Perpendicular, \perp with 590 μm EFL lens		12	36	Degrees mrad

Typical Product Characteristics

Conditions are $t_{\text{RT}} = 21^\circ\text{C}$, $t_w = 150 \text{ ns}$, $P_r = 3.33 \text{ kHz}$

	905D1S3J03X	905D1S3J06X	905D1S3J09X
Po at I_{FM} (min.)	23 W	45 W	65 W
Emitting area	85 x 10 μm	160 x 10 μm	235 x 10 μm
Max. current I_{FM}	11 A	22 A	30 A
Threshold, I_{TH}	300 mA	500 mA	800 mA
Forward voltage at I_{FM}	12 V	11 V	11 V

Absolute Maximum Ratings

Maximum ratings	Limiting values
Peak forward current (I_{FM})	50 A
Peak reverse voltage	6 V
Pulse duration	150 ns
Duty factor	0.10%
Temperature	
- Storage	-55°C to + 100°C
- Operating	-45°C to + 85°C
Lead soldering	
- 5 seconds max at	200°C

Curves

Fig. 1: 905D1S3J0XX Power vs. Forward Current

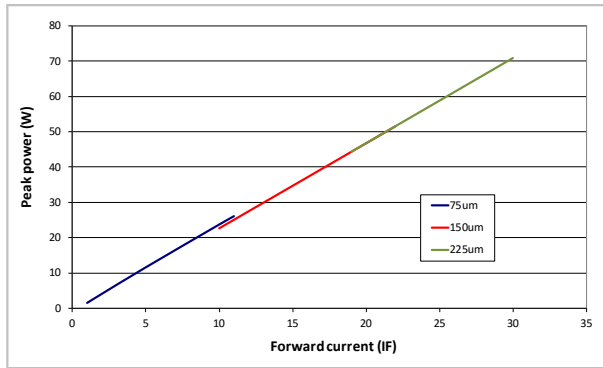

Fig. 2: Spectral Intensity Distribution

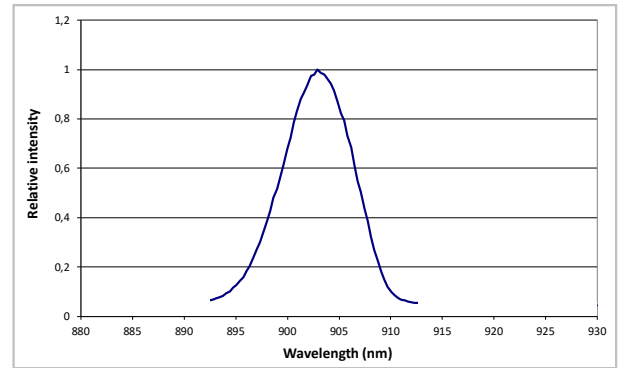

Fig. 3: Output Power vs. Temperature

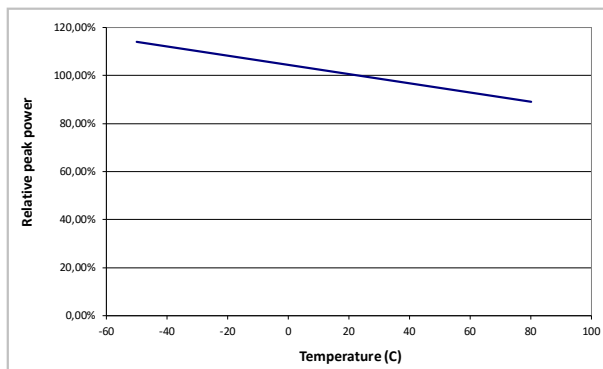

Fig. 4: Wavelength vs. Temperature

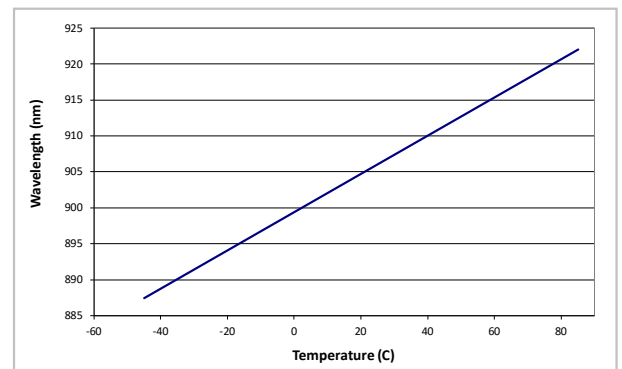

Fig. 5: 905D1S3J Series Static Vf

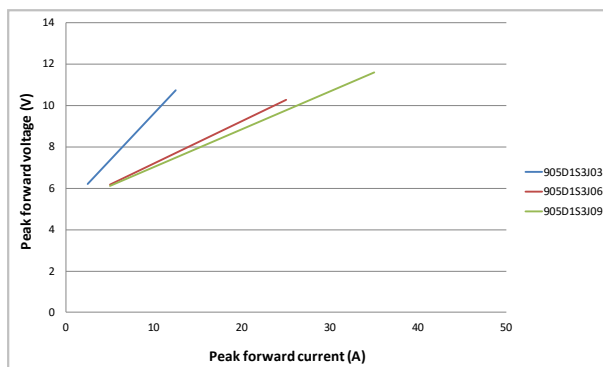
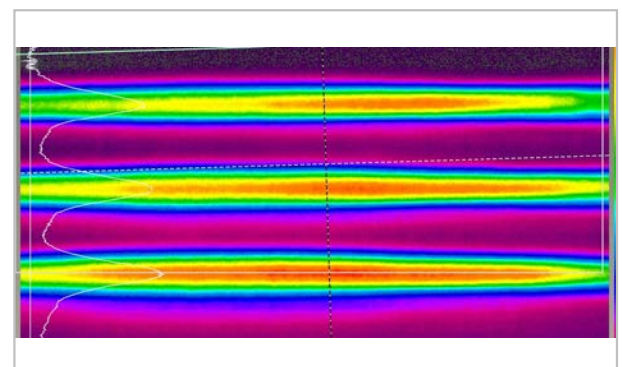
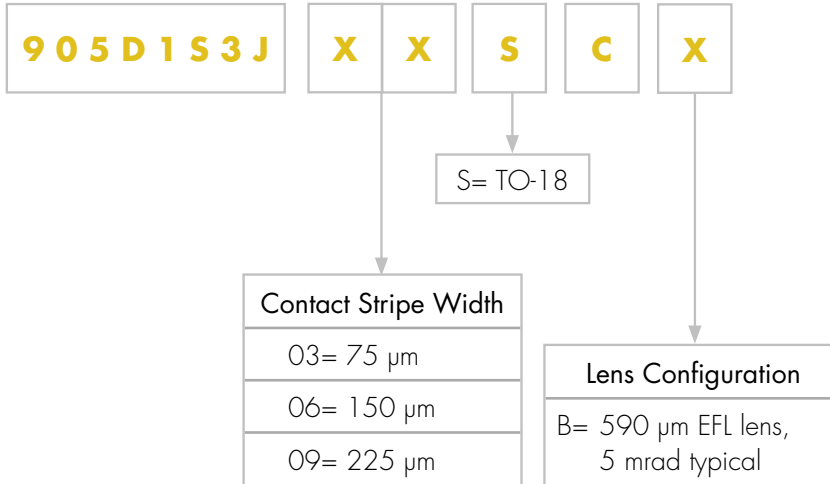

Fig. 6: Near Field



Product Number Designations



Package Drawings

Package S TO-18

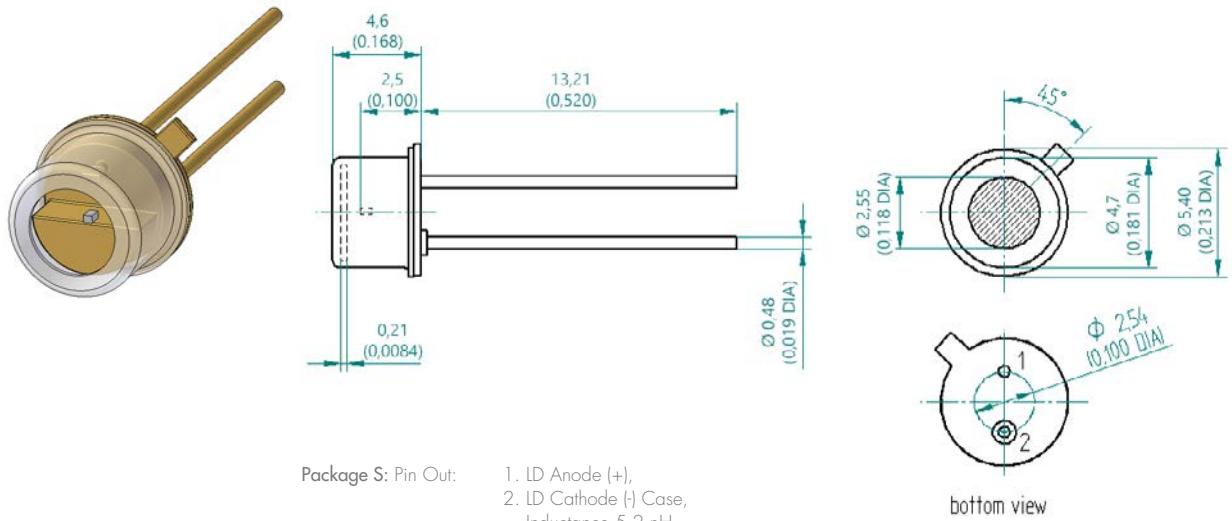

Product Changes

LASER COMPONENTS reserves the right to make changes to the product(s) or information contained herein without notice. No liability is assumed as a result of their use or application.

Ordering Information

Products can be ordered directly from LASER COMPONENTS or its representatives. For a complete listing of representatives, visit our website at www.lasercomponents.com

Custom designed products are available on request.

Laser Safety

Personal Hazard:

Depending on the mode of operation, these devices emit highly concentrated non visible infrared light which can be hazardous to the human eye. Products which incorporate these devices have to follow the safety precautions given in IEC 60825-1 "Safety of laser products".

Handling Precautions:

Products are subject to the risks normally associated with sensitive electronic devices including static discharge, transients, and overload.

